

Article number: 0101026
 Description: Retaining ring A 11 DIN 471
 Spring steel
 Note: Fitted with ZGA pilers

Measures

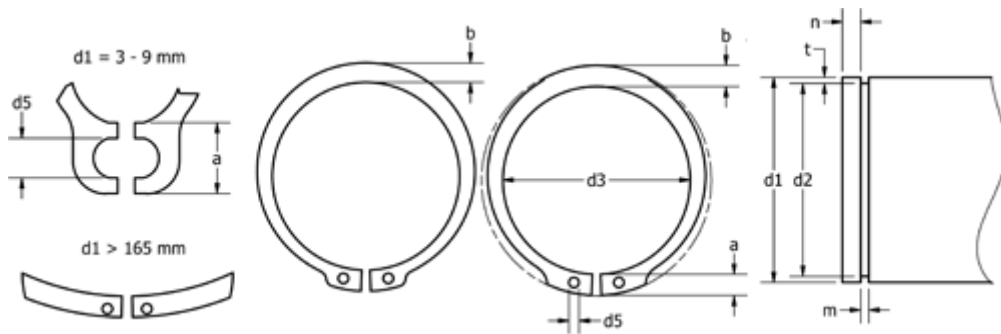

a max	= 3.3	FN kN	= 1.4	s	= 1.00
AN mm ²	= 8.4	FRg kN	= 2.40	t	= 0.25
b	= 1.8	FR kN	= 4.50	tol	= -0.11
d1	= 11	g	= 1.0	tol	= -0.06
d2	= 10.5	K kN-mm	= 26.10	tol	= +0,10-0,36
d3	= 10.2	m min	= 1.10	Tong	= ZGA-1
d5 min	= 1.5	n abl x 1000	= 70.0	Weight kg/1000	= 0.410
Description	= A11	Nominal drive	= 0.8		